



Thiesi

box

Istruzioni di montaggio

Setting up instructions

Instructions de montage

Per una corretta installazione del prodotto seguire accuratamente le seguenti istruzioni.

Prima di procedere all'installazione, verificare che il modello ricevuto sia conforme a quello ordinato, controllando l'etichetta sulla confezione.

Prima di procedere all'installazione, verificare che il piatto doccia dove si andrà a montare la cabina sia in bolla (orizzontale, planare).

IT

In caso di montaggio su piatti storti o non planari Calibe non garantisce il corretto funzionamento della cabina.

Manovrare con cautela le parti vetrate poiché trattandosi di cristalli temperati l'urto con una superficie dura potrebbe causare la frantumazione del cristallo (secondo le norme UNI EN 14428).

Prima di procedere al montaggio della cabina accertarsi che non siano state richieste modifiche all'installazione standard (come sostituzione di braccetti, misure particolari, profili particolari, ecc. ecc). Qualora non si fosse certi di ciò, contattare chi ha inviato l'ordine.

For correct installation please follow the instructions below.

Before you start installing, check the label to make sure the model you have received is the one you ordered.

Before installing, check that the shower tray is perfectly levelled, (horizontal, even).

EN

In the case of installation on irregular or uneven trays, Calibe cannot guarantee the correct functioning of the enclosure.

The glass panels are to be handled with caution, since bumping with hard parts may cause the toughened glass parts to break (as per UNI EN 14428 norms).

Before installing the enclosure, make sure there have been no requests for modification with respect to standard procedures (such as replacement of arms, specific sizes or profiles, etc.). If you are uncertain about such specifications, contact the person who sent the order.

Pour un montage correct, suivre attentivement les instructions suivantes.

Avant d'installer, contrôlez l'étiquette afin de vérifier que le modèle reçu soit conforme au modèle ordonné.

Avant d'installer, vérifier que le receveur qui sera la base de la cabine soit à niveau (horizontal, planaire).

FR

En cas de montage sur des receveurs irréguliers ou pas planaires, Calibe ne garantit pas le fonctionnement correct de la cabine.

Manipuler avec cautèle les parts en verre car en s'agissant de verre trempé tout heurt contre une partie dure pourrait causer la rupture du verre (d'après normes UNI EN 14428).

Avant de monter la cabine s'assurer qu'il n'y a aucune requête de modification par rapport à l'installation standard (par exemple substitution de bras, mesures particulières, profilés différents etc.). En cas de doutes, contacter la personne qui a envoyé la commande.

IT ATTREZZATURA NECESSARIA PER L'INSTALLAZIONE
EN TOOLS REQUIRED FOR INSTALLATION
FR OUTILLAGE NÉCESSAIRE POUR L'INSTALLATION

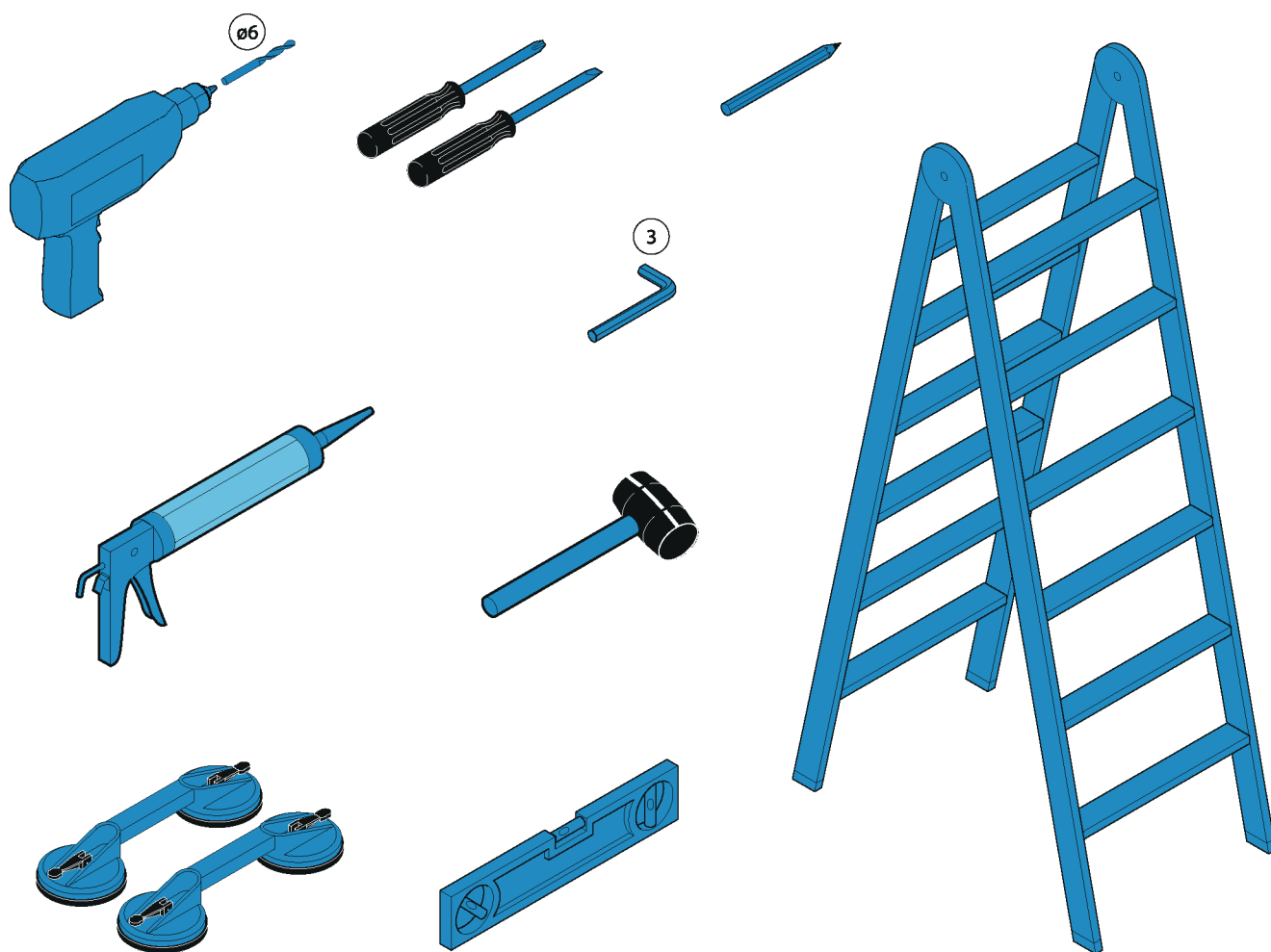

1

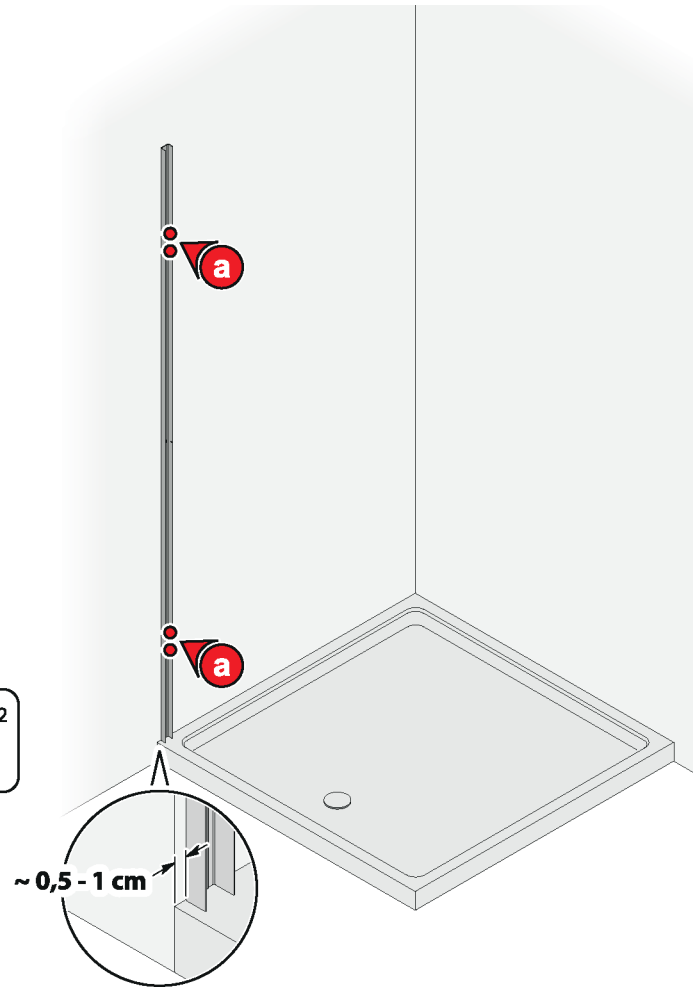
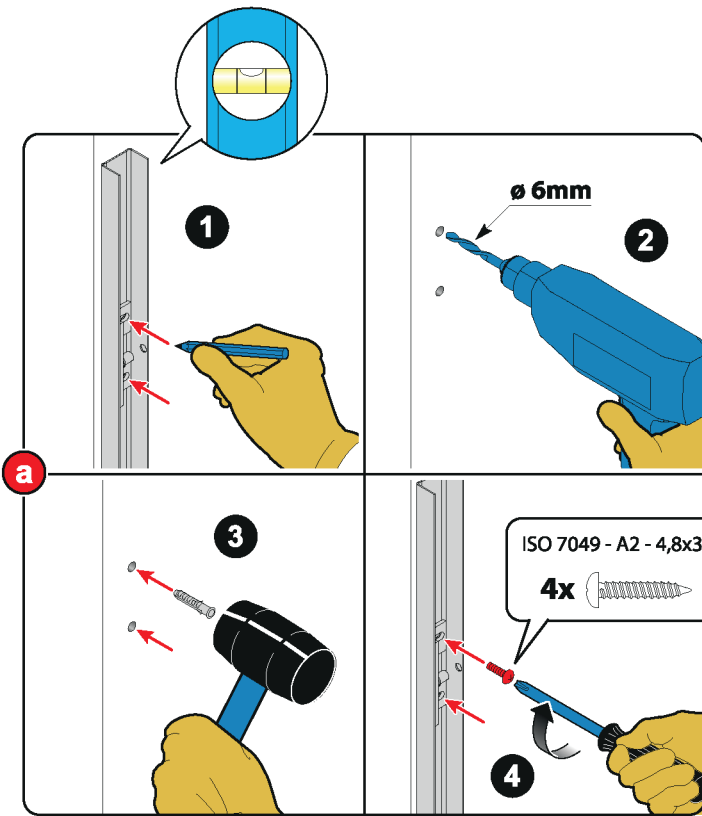

2

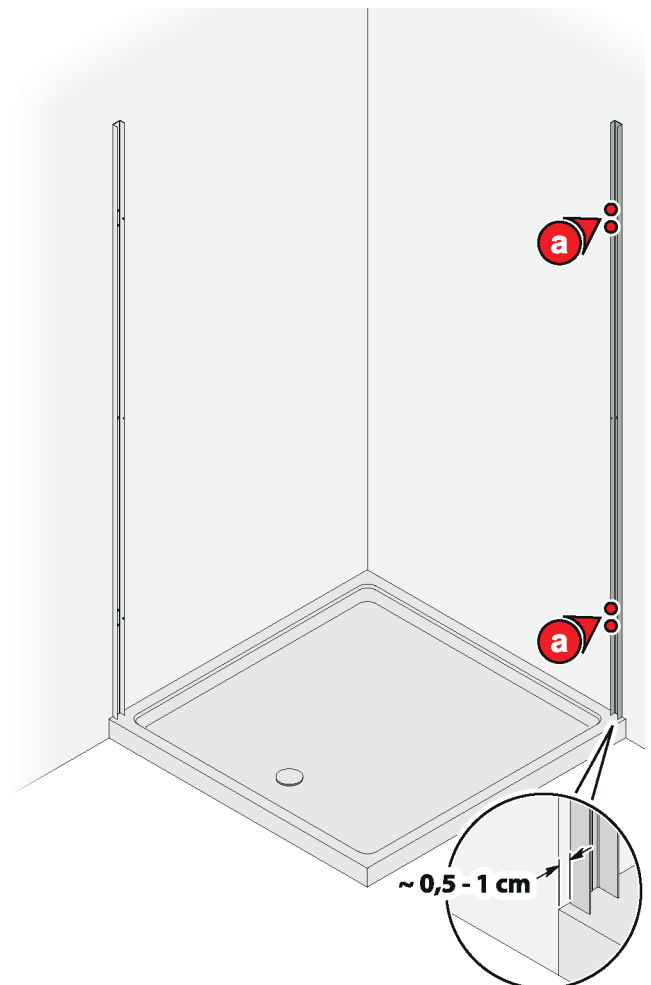
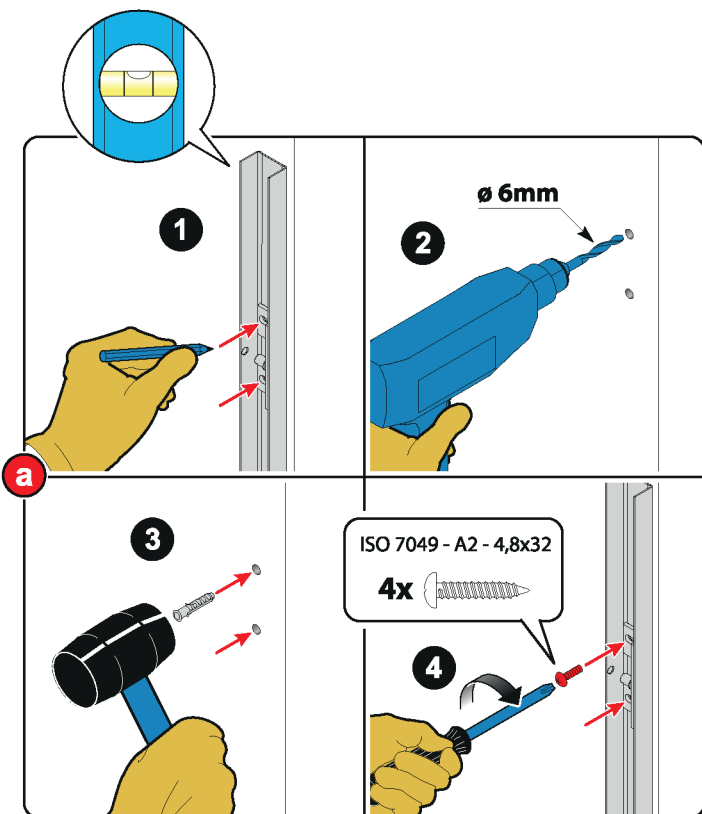

3



2x

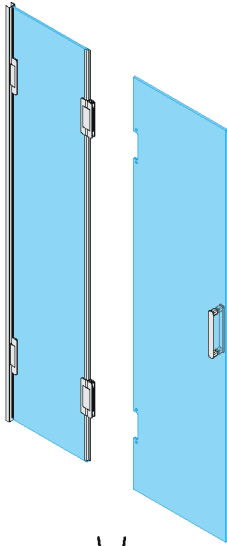

2x

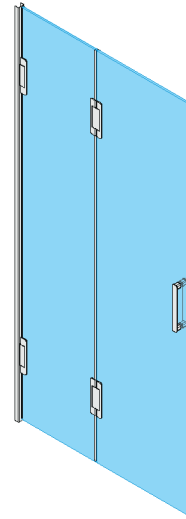

⇒ OK



7



X

✓

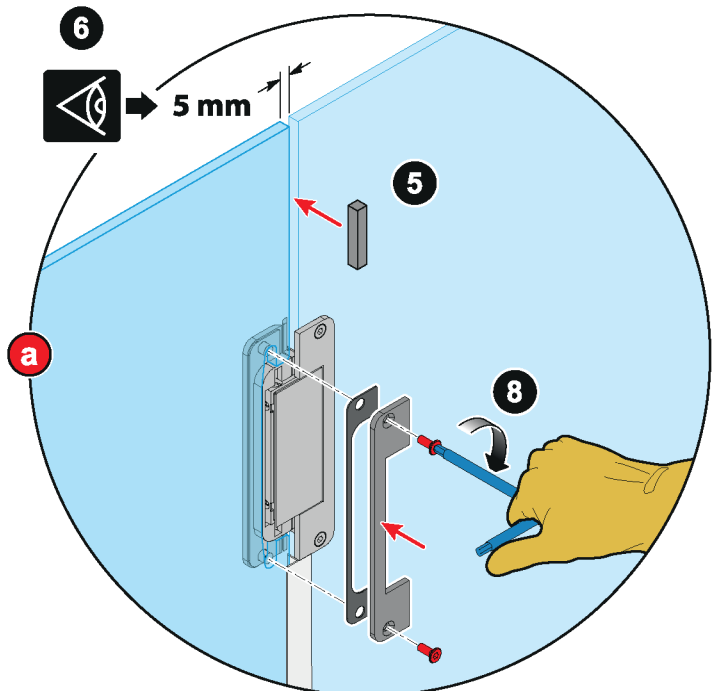
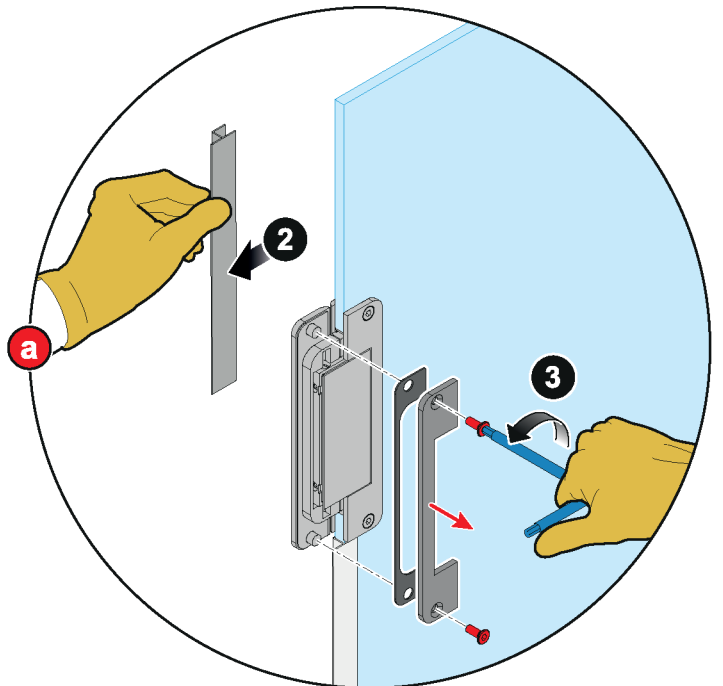
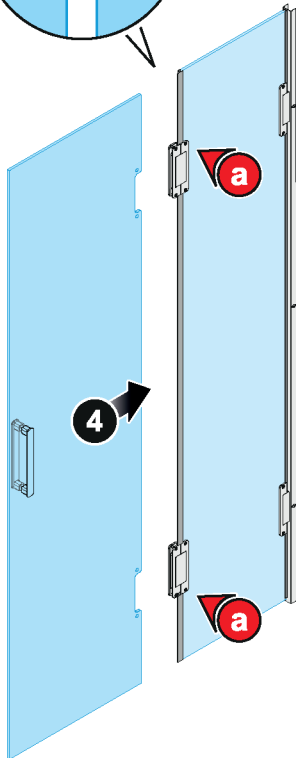
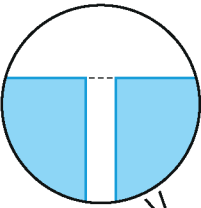
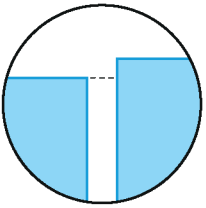

4

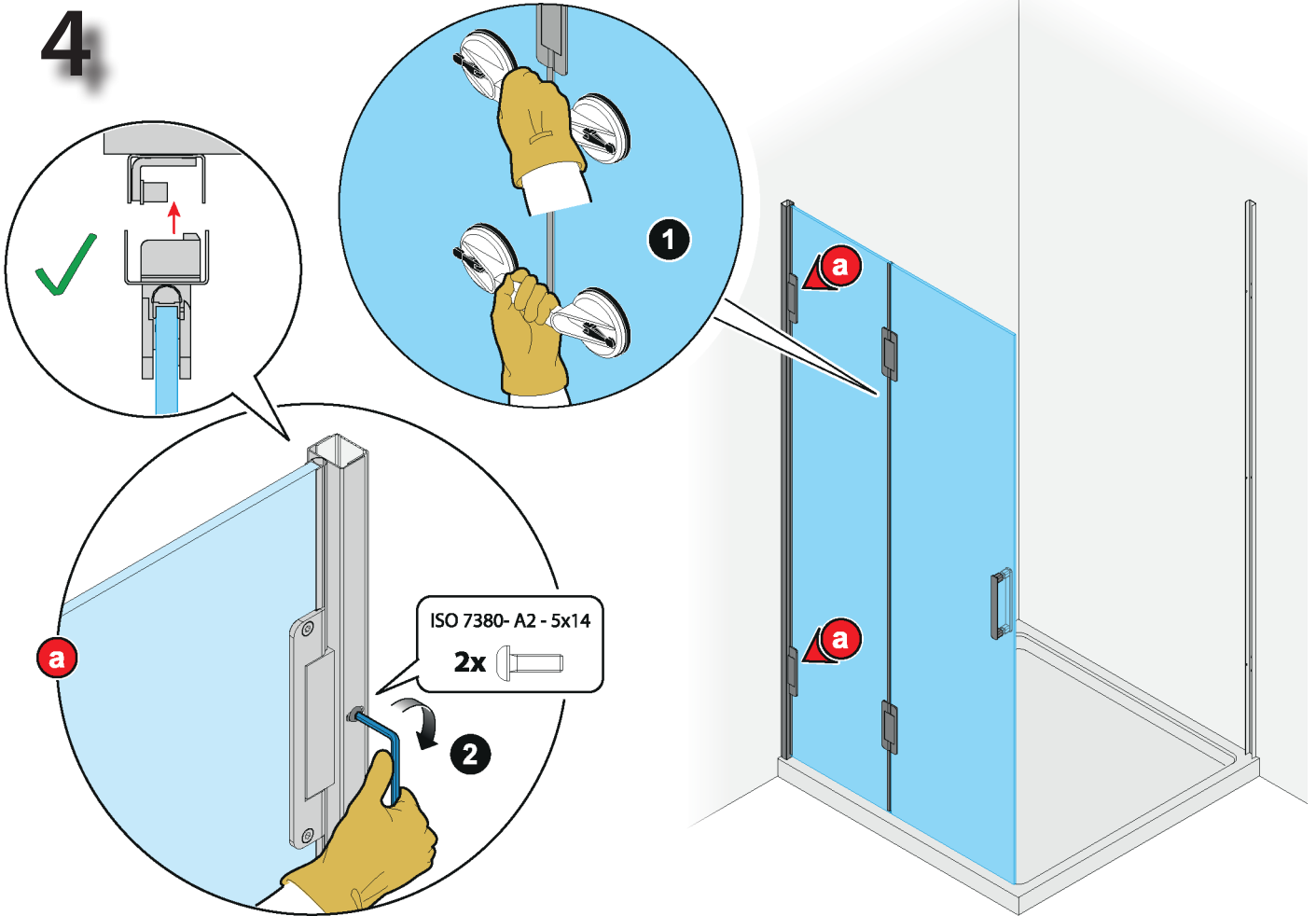

5

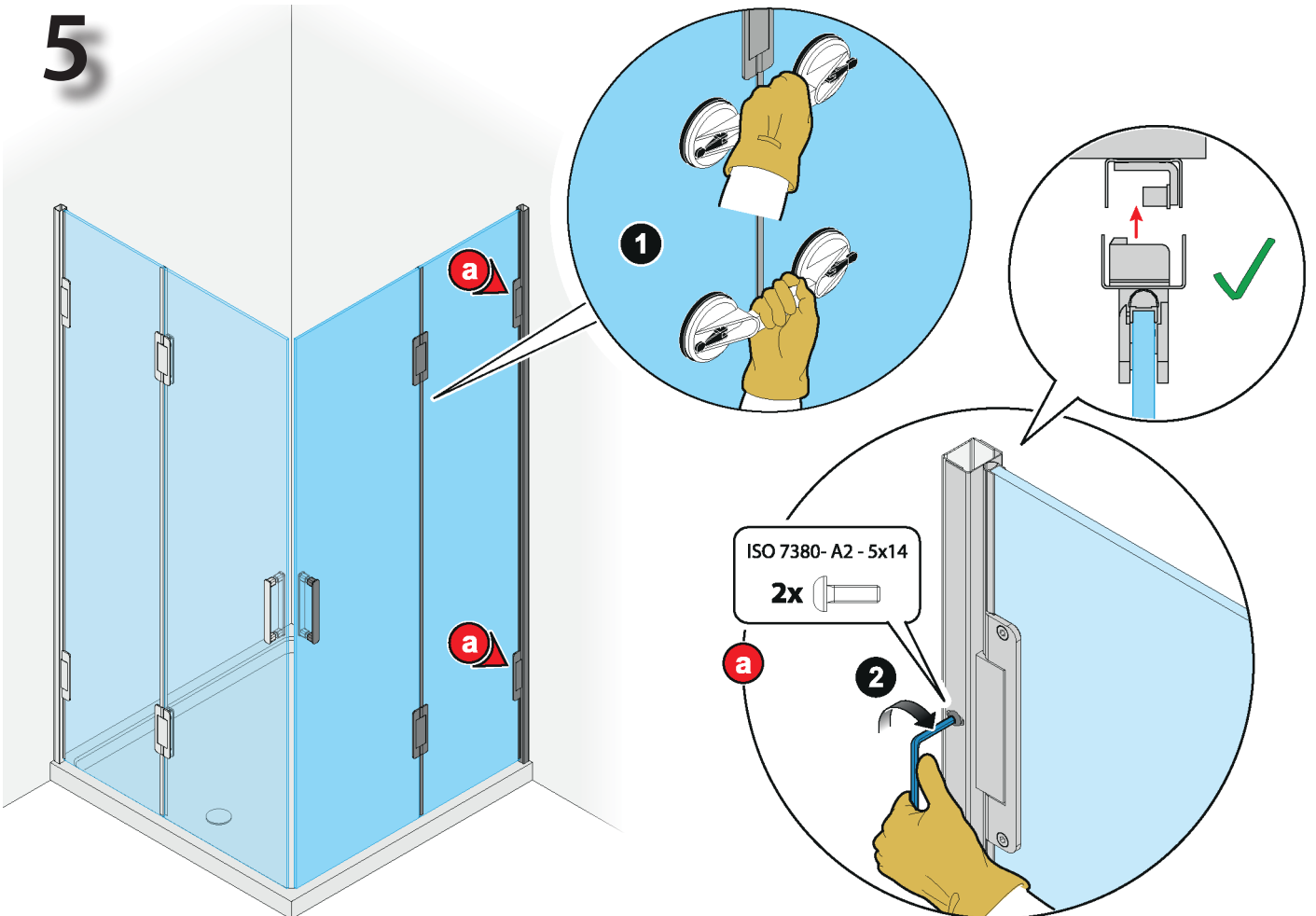

6

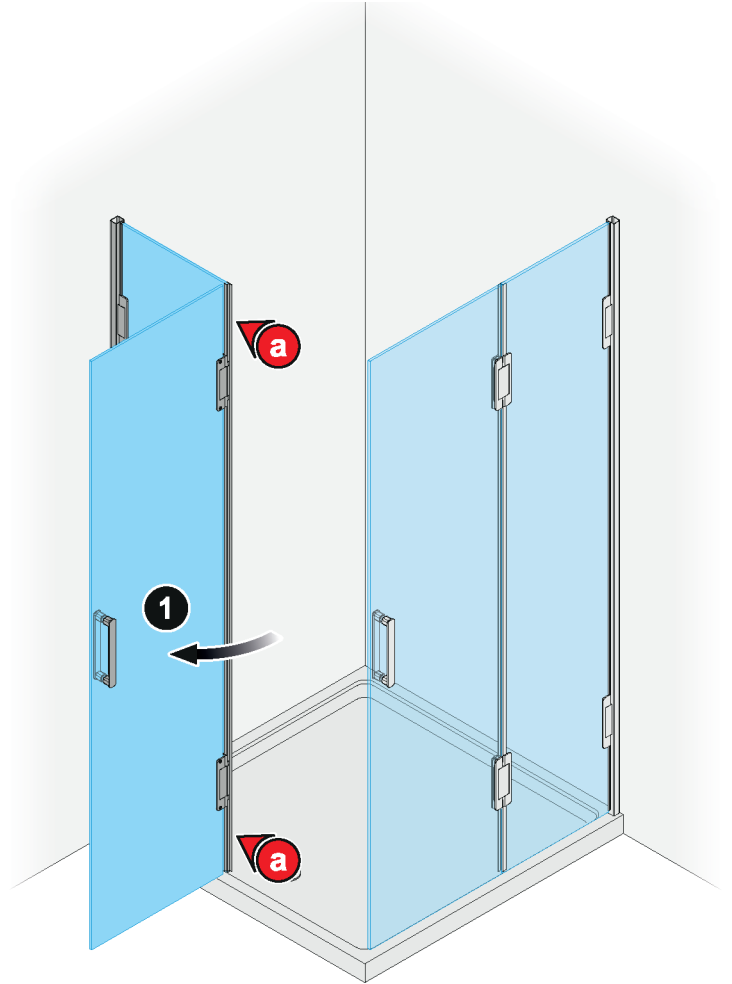
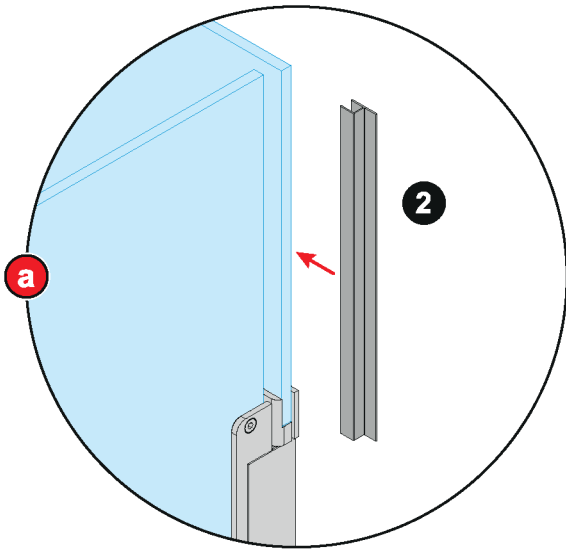

7

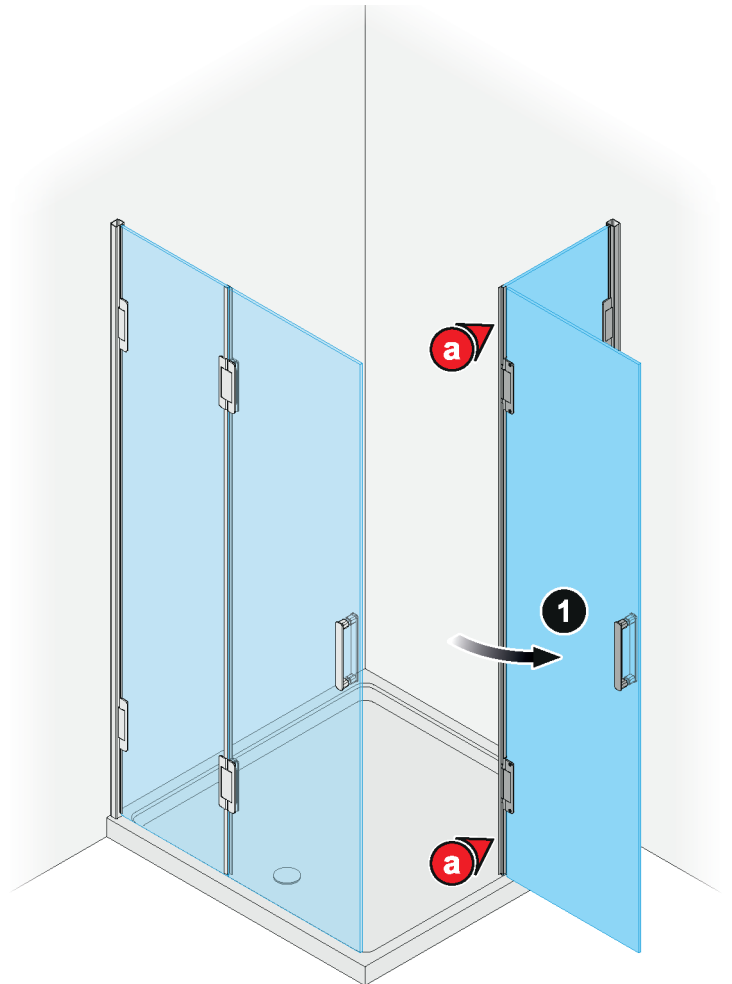
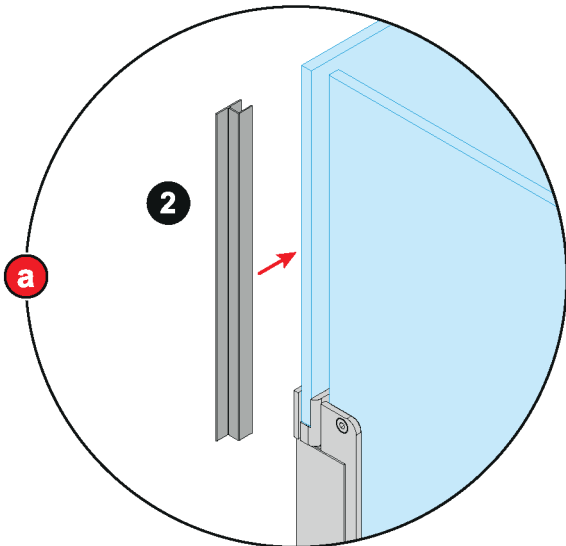

8

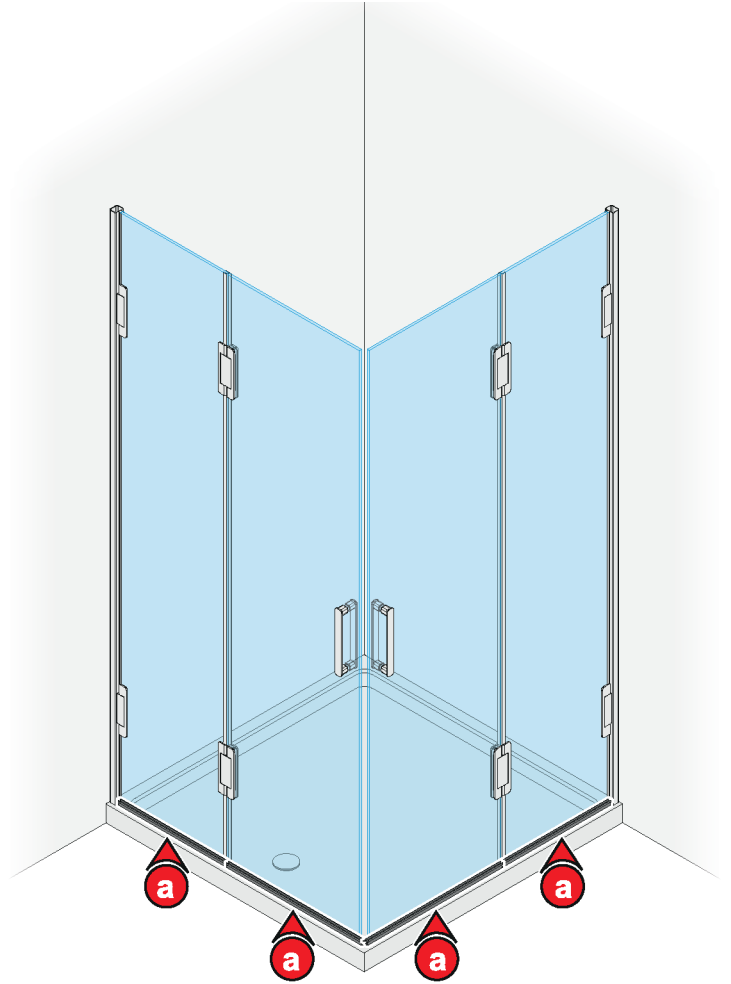
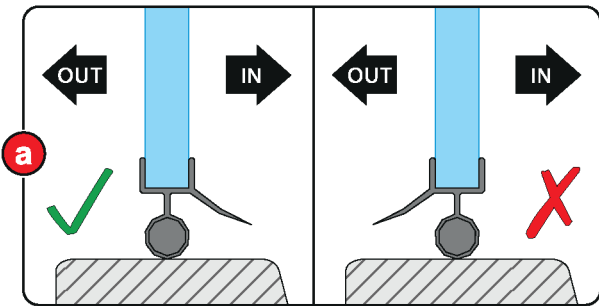
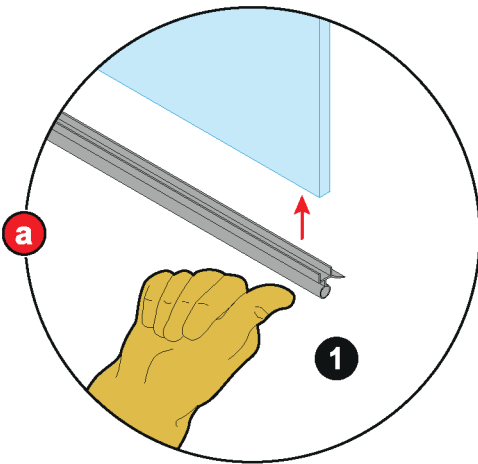

9

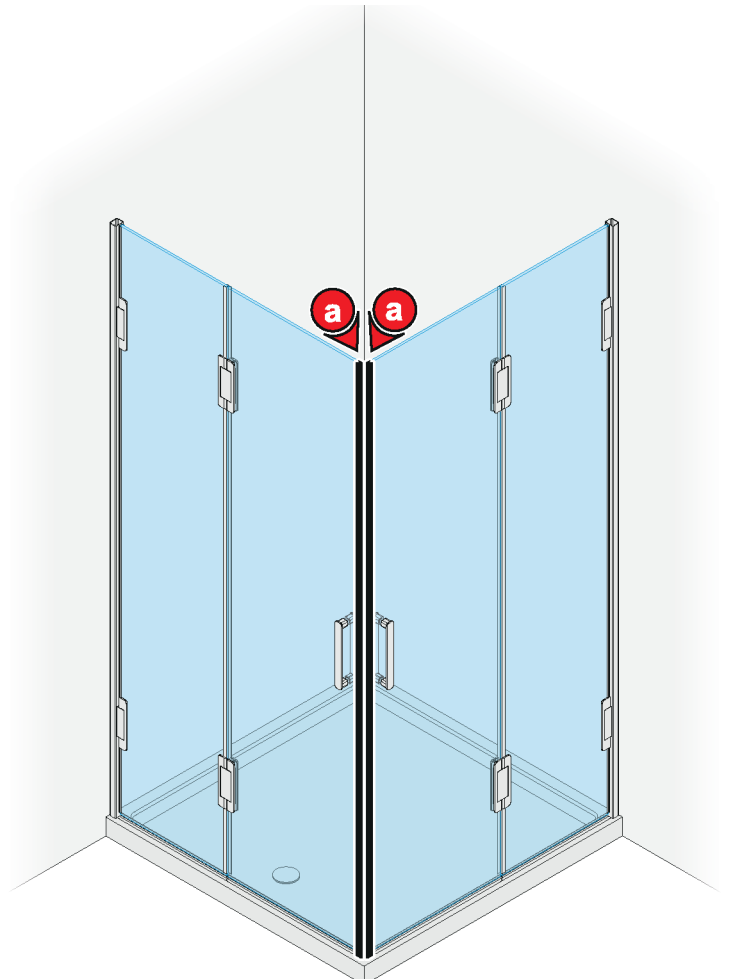
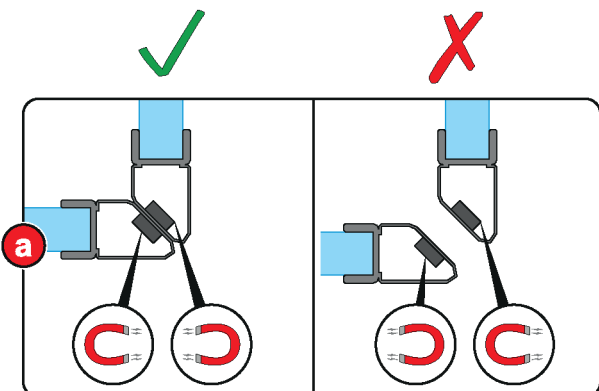
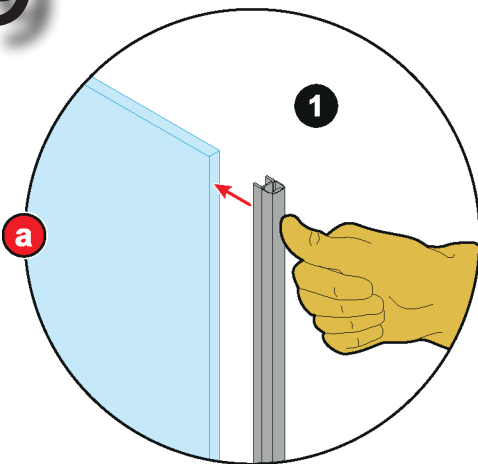

10

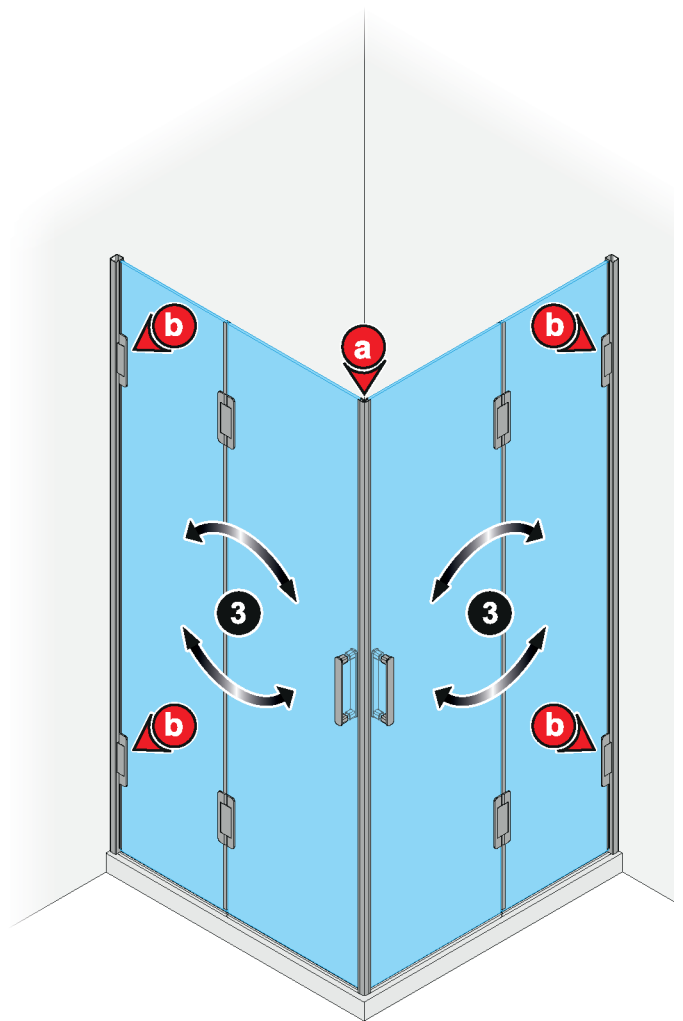
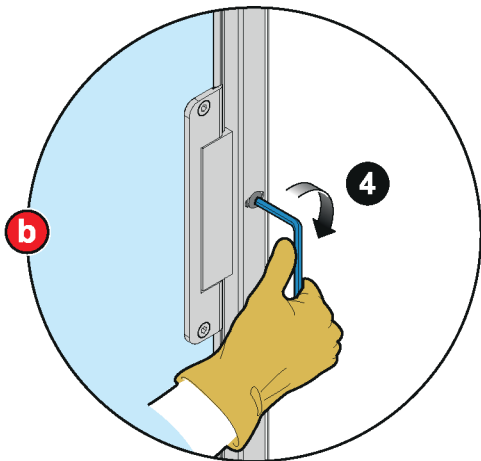
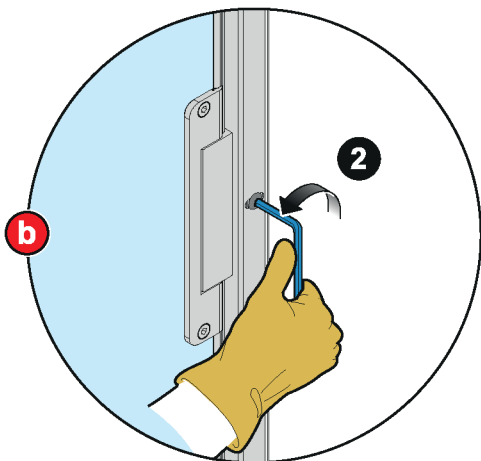
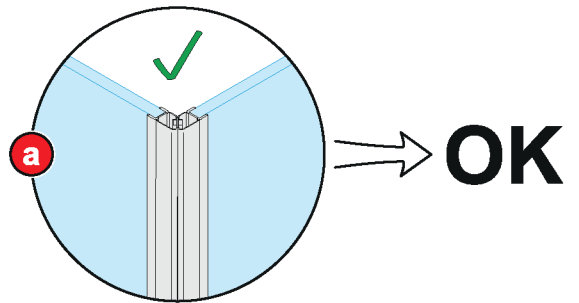
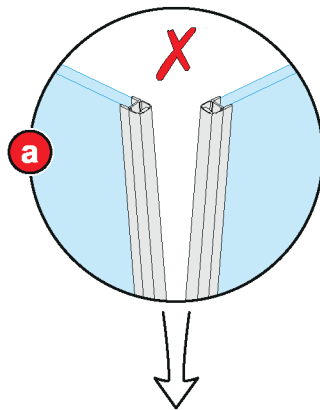
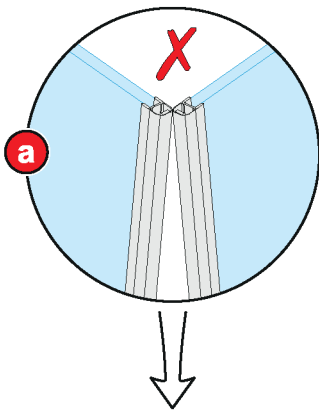
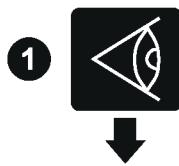



Attenzione: sigillare tutte le fessure, tra vetro e acciaio e tra acciaio e acciaio, dalle quali potrebbe uscire acqua.
Warning: seal every slot, between glass and steel or steel and steel, where water can exit.
Attention: afin d'éviter toutes fuites d'eau, sceller chaque fente, soit entre verre et acier, soit entre deux parties d'acier.

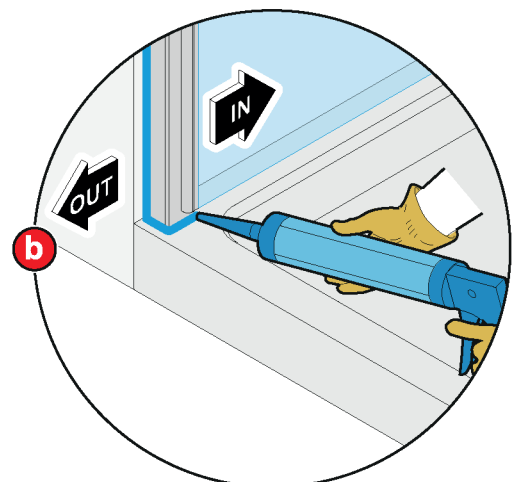
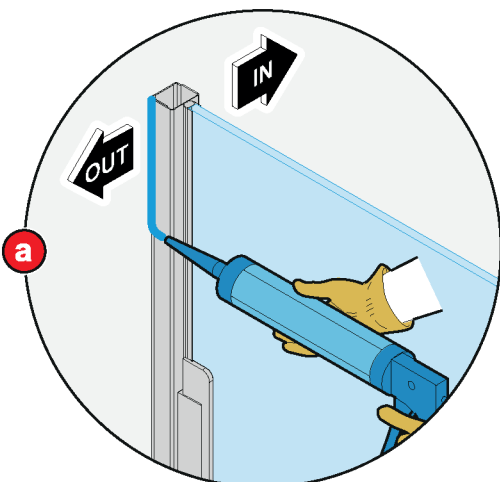
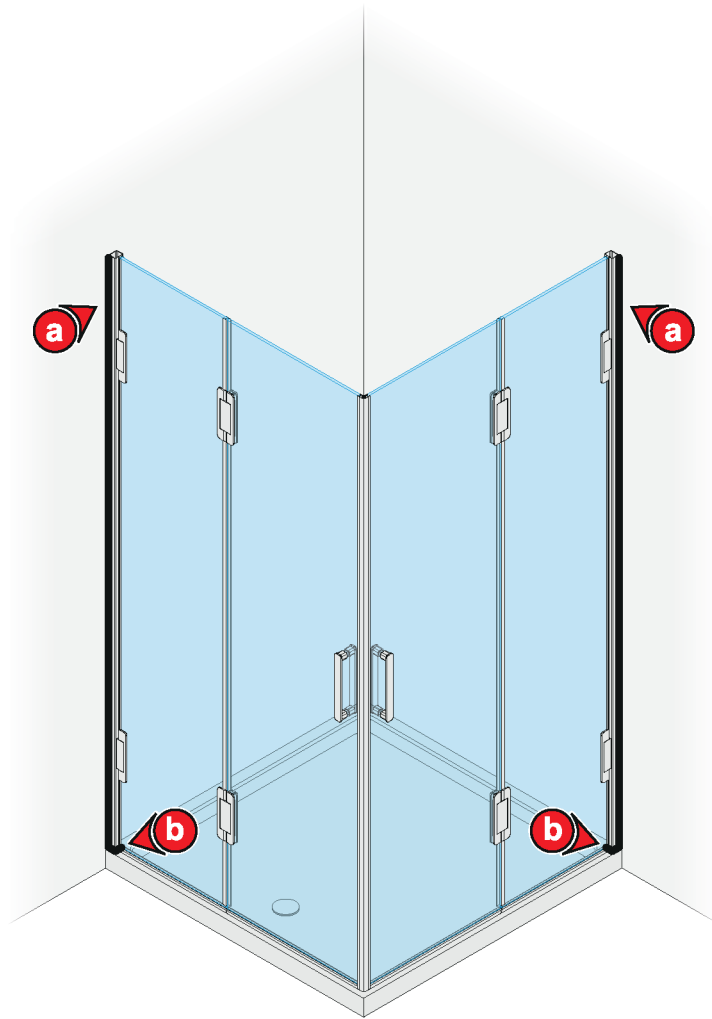



calibe

 **via Cassola, 30
40050 Monteveglio
Bologna - Italy**

 **+39 051 960320**

 **+39 051 964094**

 **www.calibe.it**

 **info@calibe.it**